

PC200 Control Box

24V DC GEAR MOTOR

FOR RESIDENTIAL
USER MANUAL

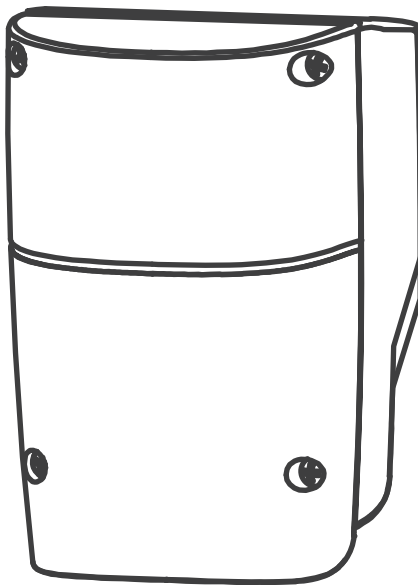

Index

1.	PC200 Control Box	2
2.	Setting	4
2.1	SW1 Dip Switch Setting	4
2.1.1	Slowdown Adjustment (Dip 1.S/F Set)	4
2.1.2	Over-current Adjustment (Dip 2.Over2 & Dip 3.Over1)	5
2.1.3	Gate Auto-close Adjustment (Dip 4.Auto 3, Dip 5.Auto 2 & Dip 6.Auto 1)	5
2.1.4	Photocells Adjustment (Dip 7.Photo)	5
2.1.5	Flashing Light Adjustment (Dip 8.Light)	5
2.2	SW2 Dip Switch Setting	5
2.2.1	Electric Latch Adjustment (Dip 5.Latch)	5
2.2.2	Slowdown Speed Adjustment of The Gear Motors (Dip 6.Slow)	5
2.2.3	Operation Speed Adjustment of The Gear Motors (Dip 7.Fast)	5
2.2.4	Single and Dual Gate Operation Adjustment (Dip 8.Ds/Set)	5
2.3	LED Indication	6
2.4	Transmitter Memorizing and Erasing Process	6
2.5	System Learning Process	7
2.6	Gate Operation	7
2.7	Gate-moving Logic	7
2.8	Advanced Operation of the Transmitter	7
3.	Trouble Shooting	8
4.	Technical Characteristics	9
4.1	PC200 Control Box	9
5.	Annexes	10
5.1	CE Declaration of Conformity	10

1). PC200 Control Box

1. Decide the installation position of PC200 control box first, it is suggested to be installed near the gate and should be protected from possible damage. Be aware of the motor cable length before deciding the installation position.
2. Remove the cover by unscrewing the four screws on the cover. See **Figure 1(1)**.
3. Use a screwdriver to puncture the holes beneath the bottom of the control box. See **Figure 1(2)**.
4. Secure it on the wall. See **Figure 1(3)**.

Figure 1(1)

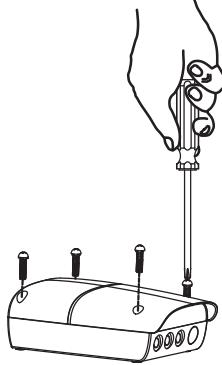

Figure 1(2)

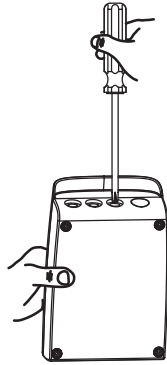
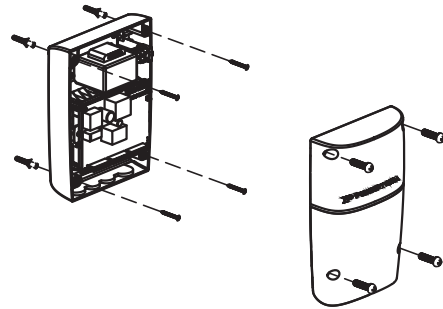

Figure 1(3)



5. Wiring Connection:

Prepare all the wires of the accessories beforehand and connect the wires to the gear motors and accessories on the PCB as shown in **Figure 1(5)**. All of the wiring connections of the accessories are not requested to distinguish the positive (+) and the negative (-) polarity.

- 1). **PF-1 Flashing light:** Connect the two wires from the flashing light to the terminal LIT (+) and LIT (-) on the PCB.
- 2). **PEL-1 Electric Latch:** Connect the two wires from the electric latch to the terminal LAT (+) and LAT (-) on the PCB.
- 3). **PW320/PW330 Gear Motors:** Refer to **Figure 1(5)** and connect the wires separately to the terminals on the PCB.

M1: Connect the motor wire (White +) to the terminals M1 (+), and (Yellow -) to the M1 (-).

Connect the hall sensor wires red, green, and black to the terminals 5V, S1, and GND.

M2: Connect the motor wire (White +) to the terminals M2 (+), and (Yellow -) to the M2 (-).

Connect the hall sensor wires red, green, and black to the terminals 5V, S2, and GND.

Notes:

For gates opened outward,

M1: Connect the motor wire (Yellow -) to the terminals M1 (+), and (White +) to the terminals M1 (-).

M2: Connect the motor wire (Yellow -) to the terminals M2 (+), and (White +) to the terminals M2 (-).

- 4). **PH-1 Photocells:** See **Figure 1(4)** and **Figure 1(5)**

(A). In the installation of one set: Connect the wires referred to 7 and 9.

And remove the electric jumper “JP1”.

(B). In the installation of two sets: connect the wires referred to 7, 8, 9 and 10.

And remove both the electric jumper “JP2” and “JP1”.

- 5). **PKS-1 Key Selector:**

For single-gate installation-Refer to **Figure 1(6)** and connect the two wires from the key selector to the terminal SKEY and GND on the PCB.

For dual-gate installation-Refer to **Figure 1(5)** and connect the two wires from the key selector to the terminal DKEY and GND on the PCB.

- 6). **PPB-1 Push Button:**

For single-gate installation-Refer to **Figure 1(6)** and connect the two wires from the push button to the terminal SKEY and GND on the PCB.

For dual-gate installation-Refer to **Figure 1(5)** and connect the two wires from the push button to the terminal DKEY and GND on the PCB.

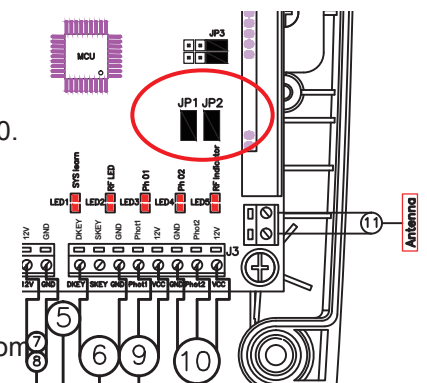

Figure 1(4)

Figure 1(5)

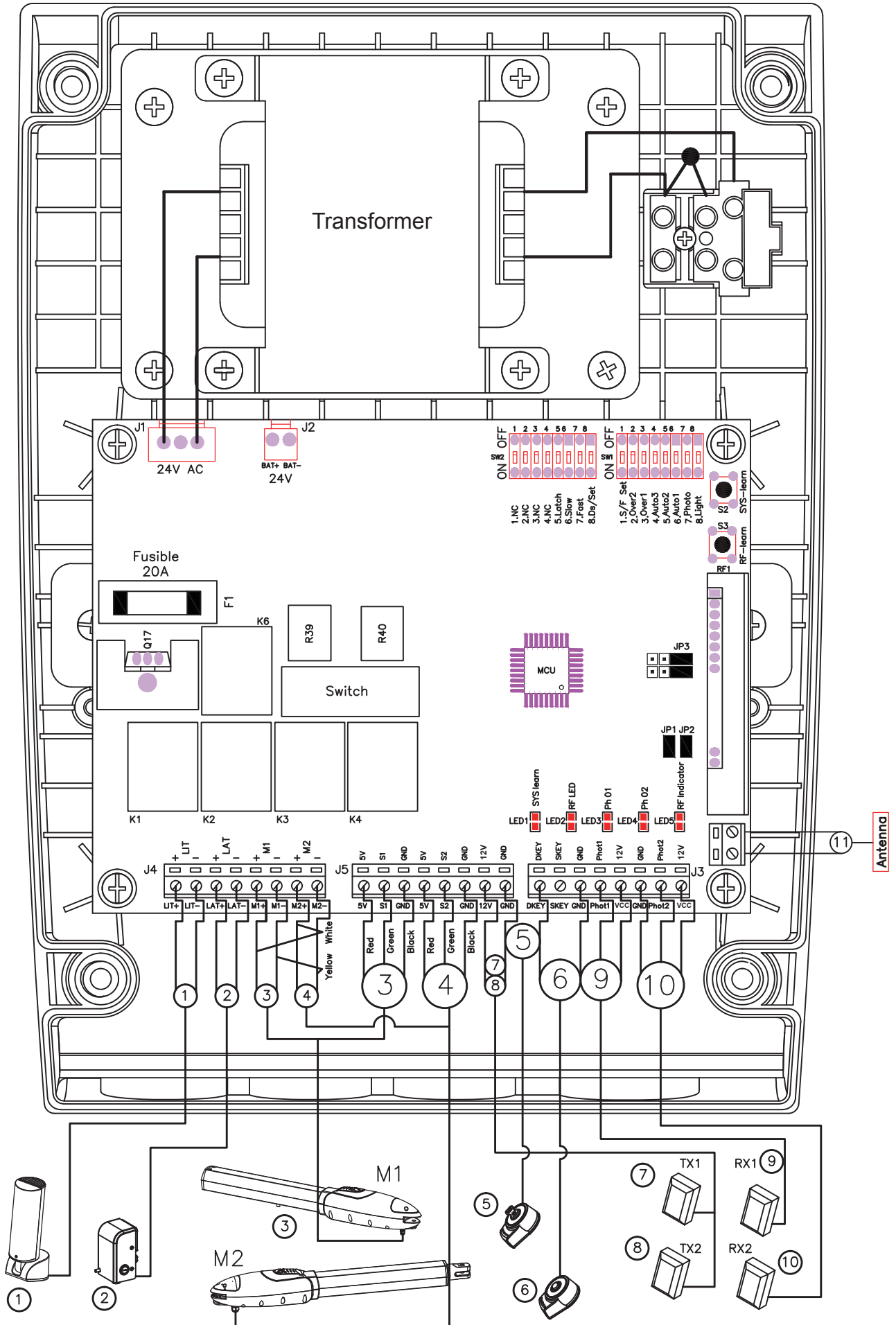
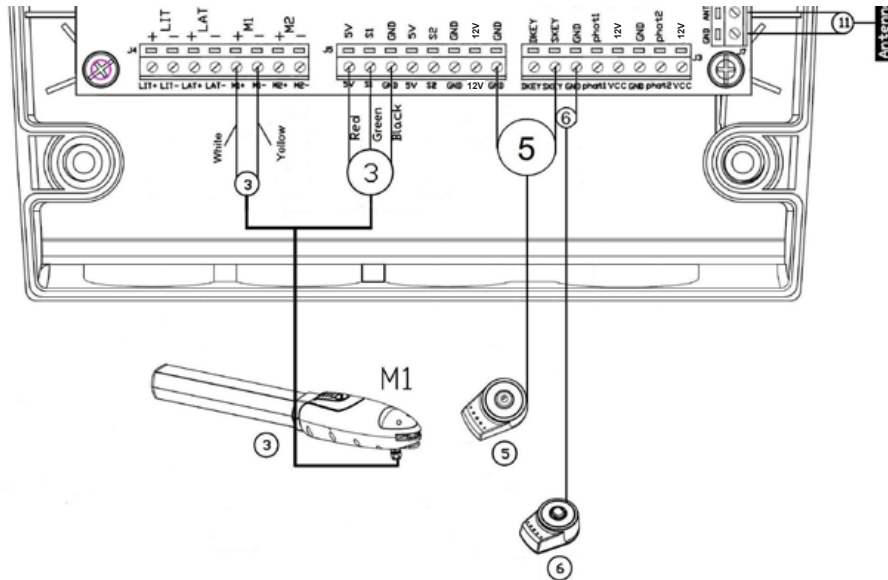
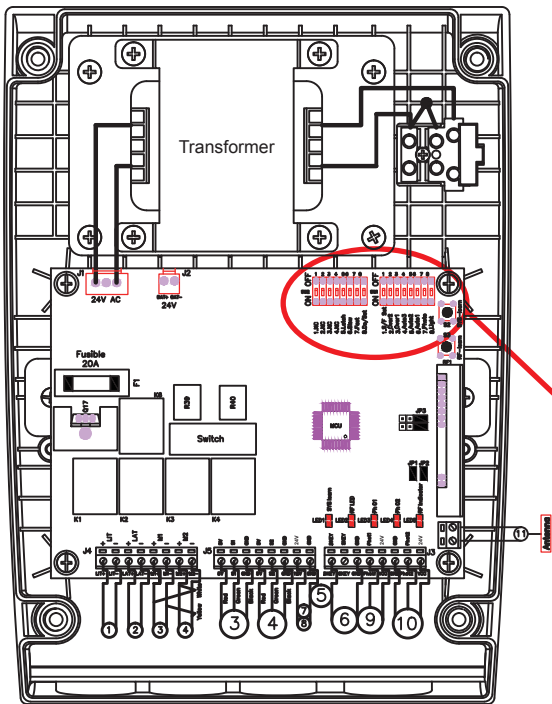

Figure 1(6)



2). Setting



Before powering on the control unit, the following dip switch setting must be decided by gate weight and installation environment first. See **Figure 2**

NC: No Connection

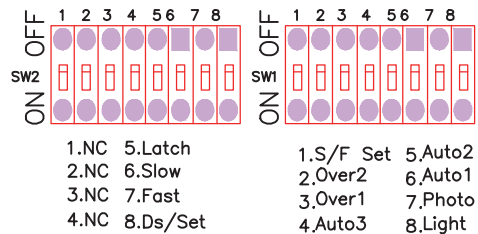

2.1 SW1 Dip Switch Setting

2.1.1 Slowdown Adjustment (Dip 1.S/F Set)

ON: The gear motors do not slow down before the gates completely close or open.
 OFF: The gear motors slow down before the gates completely close or open.

2.1.2 Over-current Adjustment (Dip 2.Over2 & Dip 3.Over1)

OVER1	OVER2	Current (Amp)
Dip Switch 3 OFF	Dip Switch 2 OFF	2A
Dip Switch 3 ON	Dip Switch 2 OFF	3A
Dip Switch 3 OFF	Dip Switch 2 ON	4A
Dip Switch 3 ON	Dip Switch 2 ON	5A

2.1.3 Gate Auto-close Adjustment (Dip 4.Auto 3, Dip 5.Auto 2 & Dip 6.Auto 1)

Auto-close 1	Auto-close 2	Auto-close 3	Effect
Dip switch 6 OFF	Dip Switch 5 OFF	Dip Switch 4 OFF	No auto-close
Dip switch 6 ON	Dip Switch 5 OFF	Dip Switch 4 OFF	3 sec.
Dip switch 6 OFF	Dip Switch 5 ON	Dip Switch 4 OFF	10 sec.
Dip switch 6 ON	Dip Switch 5 ON	Dip Switch 4 OFF	20 sec.
Dip switch 6 OFF	Dip Switch 5 OFF	Dip Switch 4 ON	40 sec.
Dip switch 6 ON	Dip Switch 5 OFF	Dip Switch 4 ON	60 sec.
Dip switch 6 OFF	Dip Switch 5 ON	Dip Switch 4 ON	120 sec.
Dip switch 6 ON	Dip Switch 5 ON	Dip Switch 4 ON	300 sec.

Note: Auto-close mode activates when the gates move to the end position or stopped manually. If the transmitter, push button, or the key selector is activated before the auto-close counting, the gate will close immediately.

2.1.4 Photocells Adjustment (Dip 7.Photo)

ON: When encountering any obstacles, the gates will stop during opening phase ; stop and reverse during closing phase.

OFF: The gate will keep moving when encountering any obstacles during closing and opening phases.

2.1.5 Flashing Light Adjustment (Dip 8.Light)

ON: The flashing light blinks for 3 seconds before the gate moves, and blinks simultaneously during the movement.

OFF: The flashing light blinks and the gate moves simultaneously.

2.2 SW2 Dip Switch Setting

2.2.1 Electric Latch Adjustment (Dip 5.Latch)

ON: The electric latch functions when dip switch is set to "ON".

OFF: The electric latch does not function when dip switch is set to "OFF".

2.2.2 Slowdown Speed Adjustment of The Gear Motors (Dip 6.Slow)

ON: The speed is 70% output of the full speed.

OFF: The speed is 50% output of the full speed.

2.2.3 Operation Speed Adjustment of The Gear Motors (Dip 7.Fast)

ON: The speed is 100% output of the full speed.

OFF: The speed is 80% output of the full speed.

2.2.4 Single and Dual Gate Operation Adjustment (Dip 8.Ds/Set)

ON: Dual Gates operation in system learning and normal operation.

OFF: Single Gate operation in system learning and normal operation.

2.3 LED Indication

LED1 System Learning: LED1 blinks once when single-gate learning is completed ;
LED1 blinks twice when dual-gate learning is completed.

LED2 RF : If the switch of the transmitter, key selector, or the push button is activated, LED2 will be on.

LED3 Photocells 1 : LED3 will be on when the first pair of the photocells are activated.

LED4 Photocells 2 : LED4 will be on when the second pair of the photocells are activated.

LED5 RF Indicator : LED5 will be on when RF signal is received.

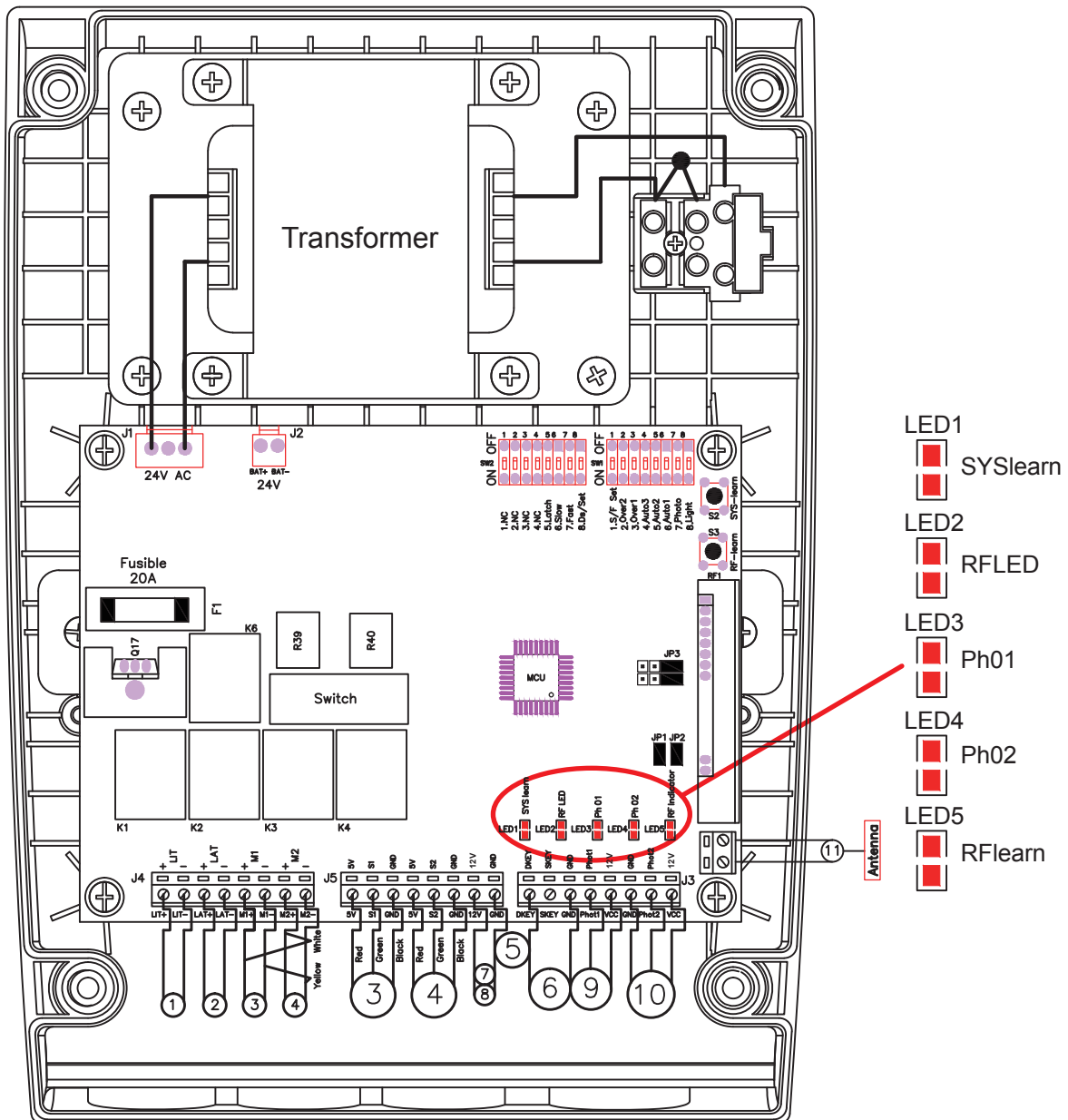

2.4 Transmitter Memorizing and Erasing Process

(A) Transmitter Memorizing: Press and hold the S3 button on the PCB for 1 second and then the blue LED indicator on the RF board will be “ON”. Press A button for dual-gate installation ; press B button for single-gate installation on the transmitter within 5 seconds. The transmitter learning is completed when the blue indicator is “OFF”.

(B) Transmitter Memory Erasing: Press and hold the S3 button on the PCB for three seconds.

(C) One radio receiver can be memorized with 200pcs of transmitters.

2.5 System Learning Process

Step1: Connect the master motor wires to M1 terminals and the slave motor wires to M2 terminals correctly. If only one gate is installed, the motor wires have to be connected to M1 terminals.

Step2: Press and hold the S2 button on the PCB for 5 seconds. After LED1 blinks once per second, press the button on the transmitter to choose dual-gate(A button) or single-gate(B button) system learning.

In system learning mode, the gates will proceed with the following procedures.

(A) Dual-Gate Mode: Slave Gate closes→Master Gate closes→Master Gate opens→Slave Gate opens→Slave Gate closes→Master Gate closes.

(B) Single-Gate Mode: Master Gate closes→Master Gate opens→Master Gate closes.

The completion of system learning:

(A) For Dual-Gate installation: The system learning is completed when LED1 quickly blinks twice per second.

(B) For Single-Gate installation: The system learning is completed when LED1 quickly blinks once per second.

Notes:

(A) System learning fails and needs to be learned again when an unpredictable interruption occurs.

(B) Once the system learning is completed, there is no need to proceed with the learning process again when there is a power failure.

(C) The slave gate opens 3 seconds after the master gate opens and the master gate closes 3 seconds after the slave gate closes.

2.6 Gate Operation

Press the button “A” on the transmitter for dual-gate operation.

Press the button “B” on the transmitter for single-gate operation in either single-gate or dual-gate installation.

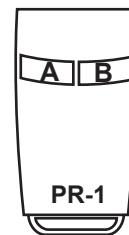

2.7 Gate-moving Logic

(A) In gate-opening phase: The gates stop if the transmitter/push button/key selector is activated, and close when the transmitter/push button/key selector is reactivated.

(B) In gate-closing phase: The gates stop if the transmitter/push button/key selector is activated, and open when the transmitter/push button/key selector is reactivated.

(C) In gate-opening or gate-closing phase: For safety purpose, the gates stop if encountering obstacles.

2.8 Advanced Operation of the Transmitter

You could decide the buttons of the transmitter to operate single or double leaf by adjusting the position of JP3 jumpers. For two channel transmitter, there are two adjustments:

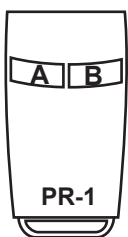

See the following description:

D _k	C	D _k	A
D	S _k	B	S _k

Situation 1:

ASk: Transmitter button A for single leaf operation.

DkB: Transmitter button B for double leaves operation.



Situation 2:

BSk: Transmitter button B for single leaf operation.

DkA: Transmitter button A for double leaves operation.



For four channel transmitter, there are four normal adjustments:

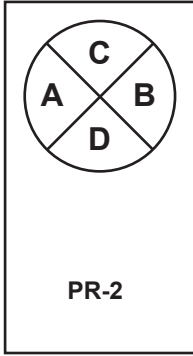

See the following description:

D _k	C	D _k	A
D	S _k	B	S _k

Situation 1:

ASk: Transmitter button A for single leaf operation.
DkB: Transmitter button B for double leaves operation.

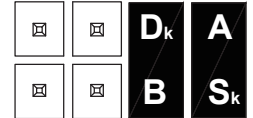

Situation 2:

BSk: Transmitter button B for single leaf operation.
DkA: Transmitter button A for double leaves operation.

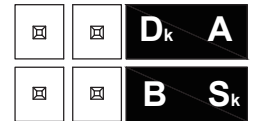

Situation 3:

CSk: Transmitter button C for single leaf operation.
DkD: Transmitter button D for double leaves operation.

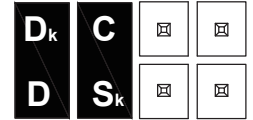

Situation 4:

DSk: Transmitter button D for single leaf operation.
DkC: Transmitter button C for double leaves operation.



3. Trouble Shooting

Overheated Back-up Batteries The gate doesn't move when pressing the button of the transmitter	Check the wiring connection of the batteries. 1. Check if LED3 or 4 is "ON". 2. Check if the voltage of the batteries is below 22V. 3. Check if LED1 is "ON". 4. Make sure all the wiring connections are firmly connected to the terminals on the PCB. 5. Make sure the fuse is workable.
The gate only moves a little distance when pressing the button of the transmitter.	Make sure the wiring connection of the hall sensor is firm.
The transmitting distance is too short	Make sure the connecting terminals of the Antenna is firm.
The gear motors run very slowly	Check the dip switch setting of the speed adjustment.
The Flashing light does not work	Check if the wiring connection of the flashing light is correct.
The leaves shall be closed instead of opening	Change the polarity connection of the positive (+) with the negative (-) of the gear motors.
The leaves suddenly stop during moving	1. Check if the "RESET" socket is activated. 2. Make sure the wiring connection of the gear motors is firm. 3. Make sure the hall sensor wiring connection is firm. 4. The GND terminal of the photocells on the PCB must be short-circuited if no photocells installed. 5. Make sure the fuse is workable.
The leaves does not move or only move toward one direction	1. Check if the "RESET" socket is activated. 2. Make sure the wiring connection of the gear motors is firm. 3. Make sure the hall sensor wiring connection is firm. 4. The GND terminal of the photocells on the PCB must be short-circuited if no photocells installed.
The master gate closes to the end first and the slave gate stops, the flashing light blinks fast for five seconds.	Cut off the AC input power and the output of the batteries. Release the master gate and slave gate manually, then open the master to the end and close the slave gate to the end by hand, then power the whole unit by connecting the AC and battery terminals.
The gear motors does not run and the relay is noisy when operating the gate opening and closing	Check if the fuse is burned.

4) Technical Characteristics

4.1 PC200 Control Box

Application	For PW220/PW230 powerFor PW320/PW330 power supply
Main power supply	230Vac/110Vac, 50Hz/60Hz
Back-up battery	2pcs of batteries for emergency operation, 1.2A each
Transformer	6A, 24V
Receiver board	433.92MHz; 200 transmitters memory
Installation	Wall mounted vertically
Operating Temperature	-20°C~+50°C
Dimension	275mm * 195mm * 102mm

